

REST TIME



counting
sheep

“**A** day without a nap is like a cupcake without frosting.” – Anonymous

Most children benefit from a brain-boosting, refreshing power nap. At Children’s Factory, we strive to provide the most comfortable cots, rest mats and accessories to ensure kids don’t make it past the first sheep. Our options are easy to clean and store, which means transitioning from go-time to quiet-time (and vice versa) is effortless.



SpaceLine® Cot FEATURES

- Space-saving design allows nearly double the cots to be nested in each stack!
- Available in 4 earth-tone colors – specify when ordering
- Fully enclosed ends
- Made of comfortable, strong, bleach-cleanable vinyl coated mesh
- Heat-sealed seams mean no loose threads
- Accommodates up to 110 lbs.
- Ships fully assembled
- 10-year warranty



2 step easy ordering process

1. Select Size

Toddler - Single Cot

AFB5731

Size: 42-1/2"l x 22"w x 5"h

Toddler - 4 Pack

AFB5736A

Size: 42-1/2"l x 22"w x 9-1/2"h stacked

Standard - Single Cot

AFB5730

Size: 55"l x 22"w x 5"h

Standard - 4 Pack

AFB5735A

Size: 55"l x 22"w x 9-1/2"h stacked

2. Select Color

CHOOSE FROM 4 COLORS



SN - Sand

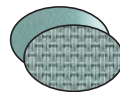

GN - Teal Green

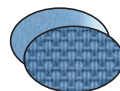

WW - Wedgewood

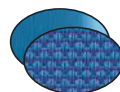

OB - Ocean Blue

For example: AFB5731**SN** is a SpaceLine® Toddler Single Cot - Sand.



STORE MORE COTS IN HALF THE SPACE



10 STANDARD COTS

10 SPACELINE® COTS



SHIPS FULLY ASSEMBLED

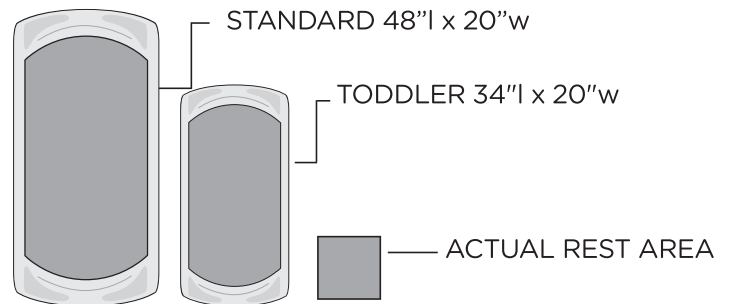



SpaceLine® 20-Cot Activity Center AFB5732

Ages: 3 years & up

Includes:

- 20 standard SpaceLine® cots
 - 1 cot carrier
 - 1 flannel activity panel with 30 flannel shapes
 - 1 pegboard activity panel with 25 pegs
 - 1 magnetic write-and-wipe activity panel with 30 magnetic letters
 - 1 preschool brick-compatible activity panel with 36 MEGA® Bloks
 - 1 activity top
 - Available GN-Teal Green, WW-Wedgewood or OB-Ocean Blue
- Size: 55-1/4"l x 31-1/2"w x 34"h

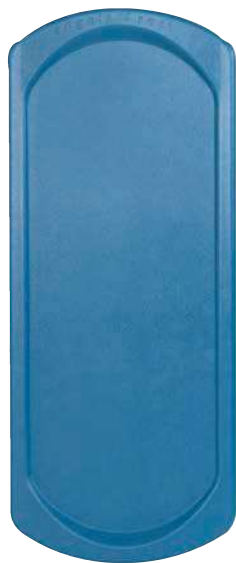

SpaceLine® Activity Table Top Only AFB5782

Features:

- Available in WW-Wedgewood and OB-Ocean Blue - specify when ordering
- Size: 54"l x 21"w x 5"h



Activity Panel 4-Pack AFB5830N

4 activity panels add function to cots when not in use.

Features:

- Fits all Angeles® cots
- Available in WW-Wedgewood and OB-Ocean Blue - specify when ordering
- Includes one of each panel: flannel, pegboard, write-and wipe and brick-compatible

Size: 19"l x 14"w x 4-3/4" each

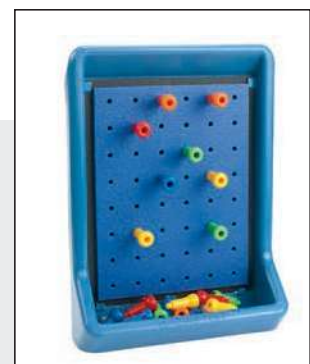

ACCESSORIES



Angels Rest™ Organic Cot Sheets

Features:

- Made from soft, 100% organic cotton
- Elastic loops keep sheet neatly in place

AFB5701TOW Toddler
Size: 38-1/2"l x 22-1/2"w

AFB5701SOW Standard
Size: 50-1/2"l x 22-1/2"w



Organic Blanket

AFB5701BOW

Made from 100% organic, washable soft cotton
Size: 54"l x 36"w



Angels Rest™ Cot Sheets

Features:

- Made from poly/cotton blend
- Elastic loops keep sheet neatly in place

AFB5700TW Toddler-White
AFB5700T Toddler-ABC Print
AFB5700TG Toddler-Gingham
Size: 38-1/2"l x 22-1/2"w

AFB5700SW Standard-White
AFB5700S Standard-ABC Print
AFB5700SG Standard-Gingham
Size: 50-1/2"l x 22-1/2"w

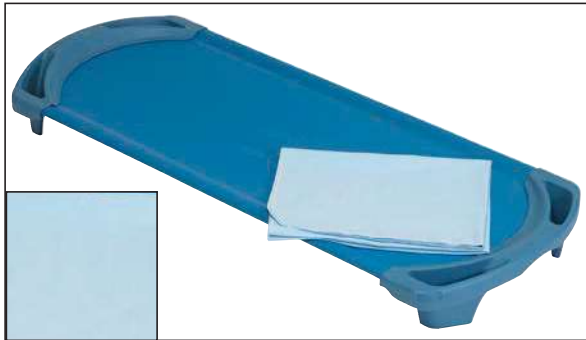

Angels Rest™ Blue Flannel Rest Blanket
CF321-104

Features:

- Made of blue flannel
 - Serged edges
 - Perfect for cots or rest mats
- Size: 58-1/2"l x 35-1/2"w

Universal Cot Carrier
AFB5727



Features:

- Fit all Angeles® cots
 - Adjustable to accommodate standard or toddler cots
 - Holds up to 24 cots
 - 3" casters allow easy maneuvering (2 locking)
- Size: 34-1/2" to 47-1/4"l x 21"w x 4-3/4"h

Cot Name Clip 5-Pack
AFB5741



Features:

- Fit all Angeles® cots
 - Clips easily to side of cot
 - Holds 3/4"h name insert (inserts not included)
- Size: 3-1/2"l x 2-3/4"w x 1"h

Value Line™ Cot FEATURES

- Made of tough vinyl-coated mesh bed with “super-grip” closure at the foot end to adjust tautness.
- Easy to wipe clean
- Royal blue color
- Accommodates up to 110 lbs.
- 10-year warranty



Value Line™ Cot Sheets

Features:

- Made from 50% polyester / 50% cotton
- Elastic loops sewn on all 4 corners

AFB5705T Toddler

Size: 40”l x 22”w

AFB5704S Standard

Size: 51”l x 22”w

Toddler Single Cot - Assembled

AFB5754

Size: 39-3/4”l x 21-3/4”w x 5”h

Toddler 4-Pack - Unassembled

AFB5757

Toddler 4-Pack - Assembled

AFB5755

Size: 39-3/4”l x 21-3/4”w x 10”h stacked

Standard Single Cot - Assembled

AFB5750

Size: 55”l x 22”w x 5”h

Standard 4-Pack - Unassembled

AFB5753

Standard 4-Pack - Assembled

AFB5751

Size: 55”l x 22”w x 10”h stacked

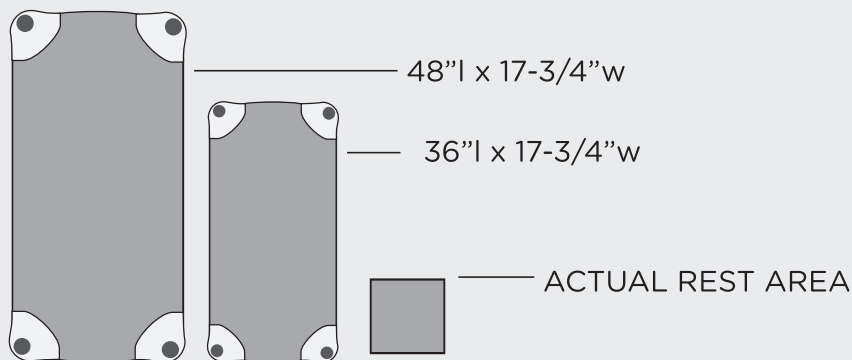



Non-Folding Rest Mat FEATURES

- 48"l x 24"w x 2" thick foam pad for restful napping
- Easy to wipe clean covers
- Available in 10 colors
- Clear, plastic, name tag holders are provided at the end of each mat



Rainbow Rest Mats

- CF350-019 Blue
- CF350-020 Green
- CF350-021 Purple
- CF350-022 Red
- CF350-023 Yellow
- CF350-034 Set of all 5 colors

Cozy Woodland Rest Mats

- CF350-039 Deep Water Blue
- CF350-040 Sky Blue
- CF350-041 Sage Green
- CF350-042 Walnut
- CF350-043 Almond
- CF350-044 Set of all 5 colors

Pillow Case Sheet

CF320-007



Made of poly/cotton blend able to slip over a 1" or 2" thick 48" x 24" rest mat.

Fitted Sheet for 1" and 2" thick Rest Mats

- CF320-006 Single
- CF320-006-12 12-Pack

Made of poly/cotton blend with corner pockets to slip over a 1" or 2" thick 48" x 24" rest mat.



Bound Rest Mat FEATURES

- Sectioned for quick folding and convenient storage
- Covered in wipe-clean vinyl
- Waterproof seals between each section
- Tear-proof sewn edges



2" Super Rest Mat

AEL7110A Single
AEL7110PK5 5-Pack

Features:

- Triple-ply with nylon mesh sandwiched between two layers of heavy duty vinyl
 - Dual color combination to easily assign sleeping and floor sides
- Size: 50"l x 25"w



Tough Duty Folding Rest Mat

CF400-002 Single 1"
CF400-052 10-Pack 1"
CF400-003 Single 2" (shown)
CF400-053 5-Pack 2"

Features:

- Blue on both sides with white trim
 - 1" mat folds to 24"l x 12-1/2"w x 4-1/4"h
 - 2" mat folds to 24"l x 11"w x 8-3/4"h
 - Fitted sheet for Tough Duty rest mat is CF320-006-12 (set of 12) sold separately on page 166
- Size: 48"l x 24"w



Pillow Folding Rest Mat

CF400-001 Single
CF400-011 10-Pack

Features:

- 4-section mat has 1 thicker foam piece to provide soft pillow for nap time.
- Dual color combination to easily assign sleeping and floor sides
- Folds to 20"l x 12-3/4"w x 4"h
- Fitted sheet for pillow folding mat is CF320-005-12 (set of 12) sold separately on page 168



Soft Cotton Blanket

CF321-102 Single
CF321-103 12-Pack

Features:

- Made of 100% soft white, double-napped cotton
- Serged edges
- Perfect for cots or rest mats

rest mats • REST TIME

Angels Rest® Nap Mat FEATURES

- Sectioned for quick folding and convenient storage
- Covered in wipe-clean vinyl
- Waterproof seals between foam sections and around all edges for total protection



3/4" 3" Section

Economy Angels Rest™ Nap Mat

CF400-501 Single 3/4"
CF400-526RB 15-Pack

Features:

- Dual color combination to easily assign sleeping and floor sides
 - 3-Sections fold to 19"l x 15-1/4"w x 2-1/2"h
 - Fitted sheet for economy folding mat is CF320-005-12 (set of 12) sold separately on page 168.
- Size: 45"l x 19"w x 3/4"h



Value Line™ 4-Section Rest Mat Storage

ANG7163 Holds 4 (2") Mats

Size: 25"l x 17"d x 28"h



ANG7162 Holds 8 (2") Mats

Size: 48"l x 17"d x 28"h



Features:

- Designed for 4-section rest mats
- Requires easy assembly
- Lifetime warranty



2" 4 Section

Angels Rest™ Nap Mat - 4-Section

CF400-508RB Single 1"
CF400-525RB 10-Pack 1"

Size: 48"l x 24"w x 1"h mat folds to 24"l x 12"w x 4-1/4"h

CF400-509RB Single 2"
CF400-519RB 5-Pack 2"

Size: 48"l x 24"w x 2"h mat folds to 24"l x 12"w x 8-1/4"h

Features:

- Fitted sheet for 4-section folding mat is CF320-006-12 (set of 12) sold separately on page 166.



Fitted Sheet for 3/4" Thick Rest Mats

CF320-005 Single
CF320-005-12 12-Pack

Features: Cotton/poly blend with corner pockets to slip over a 3/4" thick mat
Size: 46-1/2"l x 20-1/2"w

Clear Mat Dividers - Set of 5

CF322-469

Clear Mat Dividers provide hygienic protection between mats. Dividers are reinforced with grommets and attach with sliding hooks to our Universal Rest Mat Cart (AFB7930) Rest Mats and Universal Rest Mat Cart sold separately.
Size: 50"l x 24"w



Angels Rest™ Nap Mat - 3-Section 1" Mat
 AEL7121A Single
 AEL7121P10 10 Pack
 Size: 48"l x 21"w x 1"h mat folds to 21"l x 12"w x 4-1/4"h



Angels Rest™ Nap Mat - No-Fold 2" Mat
 AEL7105A Single
 AEL7105PK4 4-Pack
 Size: 49"l x 24"w x 2"h



Universal Rest Mat Cart
 AFB7930 

- Features:
- Stores 40 (1") or 20 (2") rest mats
 - Powder coated heavy-duty steel and wire frame construction
 - Rolls easily on four 3" rubber casters (2 locking)
 - Assembly required
- Size: 52"l x 26"w x 54"h



Value Line™ 3-Section Storage
 ANG7168 Holds 4 (2") Mats 
 Size: 25-1/2"l x 16-3/8"d x 37-1/2"h

ANG7167 Holds 8 (2") Mats 
 Size: 50"l x 16-3/8"d x 37-1/2"h

- Features:
- Designed for 3-section rest mats
 - Requires easy assembly
 - Lifetime warranty

NURSERY



“It takes a whole village to raise a child.” - African Proverb
A preschool nursery is where youngsters experience the nurtured life apart from their parents. Our complete nursery selection creates a warm environment for the most vulnerable to experience safety and comfort.

the
nurtured
life



Changing Table with Locking Stairs
AEL7550

Features:

- Single piece molded top is easy to clean and maintain
- No sharp corners or crevices to harbor dirt and bacteria
- 7" d changing well allows for 1" thick mat and still meets the 6" d requirement
- Features roll-out stairs that safely lock into place
- Eliminates lifting growing toddlers and makes changing fun
- Sturdy wood storage shelf keeps changing supplies organized and within easy reach
- One roll of sanitary paper included
- 1" changing table pad included
- Accommodates up to 100 lbs.
- Ships fully assembled via freight only 🚚
- 5-year warranty

Size: 46"l x 23"w x 37"h
Inside shelf: 18"l x 23"w x 12"h



Changing Table with Slide-Out Steps
ANG1039S

Our innovative, no-strain table lets tots step right up, so you never have to lift them!

Features:

- Behind the left door hides a compact stairway that slides out on tracks. With a helping hand, children can walk right up to the table
- Behind the right-hand door is storage
- The table includes a washable mattress with safety strap
- Standard 7" d changing well
- Accommodates up to 70 lbs.

Size: 40"l x 20"d x 40"h 🚚

ACCESSORIES



Germ-Free Changing Table Pad
AEL7090

Features:

- Heat-sealed construction completely seals and waterproofs pad, making it resistant to bacteria and germs.
- Cleans up quickly and easily
- Latex free

Size: 39-1/2"l x 17-1/2"w x 1"h



Changing Table Paper Roll
AEL7091

Features:

- Sanitary roll of paper for covering changing table pad (individually wrapped)
- Ideal for child care centers
- Recyclable

Size: 215"l x 14-1/2"w

changing stations • NURSERY



Value Line™ Birch Changing Table

ANG9039 

Features:

- 7" d changing well allows for 1" thick mat with safety strap included
- Features two sliding doors for easy access
- Two spacious shelves for storage
- Ships ready-to-assemble and is constructed of 11-ply, 5/8" thick birch plywood. Tools and hardware are supplied for easy assembly.

Size: 40"l x 20"d x 40"h



Diaper Wall Shelf

ANG1106

When you run out of floor space, where do you go? How about up! Organize all your changing supplies in this space-saving, wall-mounted shelf. There are divided spaces for diapers so you can sort by size or by child and 3 lower shelves that keep wipes and lotions within easy reach!

Features:

- Constructed from 5/8" thick birch veneer panels with a durable UV finish.
- Shelves are doweled and glued for lasting strength.
- Non-warping, 1/4" thick wood grain backs are recessed into side and top panels and screwed into place.

Size: 40"l x 10"d x 23"h



Value Line™ Birch Mobile Changer

ANG9040 

All your baby-changing supplies are within reach with this easy-access, open storage mobile table! Features:

- Units are constructed of 11-ply, 5/8" thick birch with a durable UV finish
- Deep, spacious shelves for supplies and diaper bags
- Standard 7" d changing well
- 1" thick changing table pad
- Tools and hardware are supplied for easy assembly
- Accommodates up to 100 lbs.

Size: 31"l x 27"d x 36"h



Changing Table

ANG1056

All your baby-changing supplies are within reach with this easy-access, open storage table!

Features:

- Constructed from birch veneer panels
- Deep, spacious shelves for supplies and diaper bags
- Standard 7" d changing well
- 1" thick changing table pad with safety strap
- Accommodates up to 70 lbs.

Size: 40"l x 20"d x 40"h 



Locking Wall Storage Cabinet

ANG1424

Space-saving, lockable cabinet with 2 full-length shelves is ideal for storing toxic materials, medication and valuables out of reach and secure.

Features:

- Constructed from 5/8" thick birch veneer panels with a durable UV finish.
- Shelves are doweled and glued for lasting strength.
- Non-warping, 1/4" thick wood grain backs are recessed into side and top panels and screwed into place.
- Ships fully assembled.
- Lock includes 2 keys.

Size: 41"l x 12"d x 25"h



Infection Control Diaper Changing Pad

CF400-407-1 Single Pack

CF400-407-5 5 Pack

Constructed of smooth vinyl with radio frequency vinyl welded seams that prevent fluids from seeping into the foam pad. Easy to clean and disinfect with bleach and water.

Size: 35-1/2"l x 16-3/4"d x 1"h



Changing Table Paper Roll Holder

ANG1110

ANG1112 Paper Roll Refill

Convenient, 2-shelf storage cabinet mounts on either end of the changing table and features a paper dispenser with a handy tear-off bar and one paper roll.

Features:

- No mounting hardware needed!
- Paper Roll Refill 225'l x 15"w

Size: 18"l x 6"d x 22"h



Value Line™ Overhead Unit

ANG7171 

Overhead easy access changing storage can be mounted where it's most convenient.

Features:

- Unit features eight, 4" w x 10" h storage slots on the top.
 - 3 lower storage areas, each 12" w x 10" h
 - Ready to assemble - cabinet hardware supplied; wall mounting hardware not included
 - Constructed of 5/8" thick maple-faced melamine panels.
- Size: 40-1/2" l x 10" d x 23" h

Value Line™ Changing Table

ANG7156 

Features:

- Ready to assemble - cabinet hardware supplied
 - Constructed of 5/8" thick maple-faced melamine panels
 - Features a 7" d changing well
 - Changing table has 1" thick pad and strap for security
- Size: 40" l x 20" d x 38-1/2" h



Changing Table - with Sliding Doors

ANG1039P

Prefer enclosed storage? Two sliding doors provide easy access to baby-changing supplies.

Features:

- Constructed from birch veneer panels with two shelves for storage
- Standard 7" d changing well
- 1" thick changing table pad with safety strap
- Accommodates up to 70 lbs.

Size: 40" l x 21" d x 40" h 





Changing Table Steps
ANG1039ST

Ages: 2 years and up
With a helping hand and no back strain, children can walk right up to the table. Each step measures 5-1/8" d x 6" h
Size: 14" l x 19" d x 30" h

"I Can Reach" Handy Steps
ANG1133

Ages: 2 years and up
Make hand washing and other counter-height activities safer and easier. Handy Step's high sides with hand-hold cutouts provide extra support and helps to prevent missteps. Steps are trimmed with non-slip treads and all edges are rounded. Fits perfectly against standard 36" high counters.
Size: 20" l x 20" d x 36" h



Children's Step/Riser
ANG1731

Ages: 2 years and up
Give students the 6" boost they need! Young learners will be eager to step up to take their turn at the board, at the sink, at the counter, or anywhere that is just out of their reach. Designed to provide sturdy access as well as ergonomic support.
Features:
• Standard with grip strips for traction
• Constructed of durable birch laminate with a safe, nontoxic natural UV finish
Size: 24" l x 14" d x 6" h



Step Stool
ANG1283

Ages: 2 years and up
Portable stool with handle is easy to transport any where you need a little extra height. Smooth, rounded corners, solid construction and no-slip grip strips on both steps provide a safe, uplifting experience for a young child.
Size: 15" l x 14" d x 13" h



Soft Step Stool
CF322-107

Ages: 12 months and up
Learning to use steps is made safer with soft, extra deep top step for stability and balance.
Size: 24" l x 16" d x 12" h

BABY CHANGERS



X-Wide Vinyl Portable Changer
CF322-146

Ages: Birth - 3 years

Changers have sloped sides with safety strap to prevent little one from rolling sideways.

Size: 30"l x 24"d x 6"h

Baby Changer

CF321-290 Primary

CF321-290P Pastel

CF349-048 Deep Water Blue/Almond

CF349-049 Sage/Almond

Ages: Birth - 3 years

Gently sloping sides safely protect baby during changes. Portable and can be used on any surface. Easy wipe clean covers.

Size: 30"l x 18"d x 6"h

Baby Mirror

CF332-158

Wall mounted mirror. Hardware not included. Size: 16"w x 12"h



SEATING



New!



Rounded Sit Me Ups

CF349-050 Deep Water/Almond

CF349-053 Sage/Almond

CF705-298PT Blue Stars

CF805-033 Two-Tone Blue

CF805-175 Almond

Ages: 4 months - 12 months

Soft U-shape gives baby security and confidence while learning to sit up.

Size: 24"l x 18"d x 6"h



Feeding Chair

AFB7940

The perfect solution for your infant/toddler feeding needs in Caramel and Creme. Floor to seat height is 9" with a seat depth of 7", and includes an adjustable restraint harness. Smooth, one-piece chair, with a one-piece removable tray (dishwasher safe) is easy to clean/sanitize. The chair stacks (without legs) up to 4 high for space-saving storage. Accommodates up to 40 lbs.
Size: 21-3/4"l x 15-1/2"d x 18-5/8"h

Feeding Chairs with Rubbermaid® Microban® Trays

- ANG1688 5"
- ANG1689 7"
- ANG1690 9"
- ANG1691 11"

This feeding chair is a low chair with a sturdy, broad base that provides safer, more stable seating for toddlers. Constructed of 5/8" thick, birch veneer panels with a removable Rubbermaid® Microban® tray that provides protection against bacteria growth and securely locks in place! Seat belts with center support are removable for cleaning. Tray measures 18-1/2"l x 11-1/2"d.
Sizes: 5"h seat - 16"l x 16"w x 14"h
7"h seat - 16"l x 16"w x 16"h
9"h seat - 16"l x 16"w x 18"h
11"h seat - 16"l x 16"w x 20"h



Infant-Toddler Table

ANG1349LT

Ages: 2 months - 3 years

Transition tots from high chairs to this unique table! Four curved cutouts help little ones sit up close for snacks or playtime. Birch veneer table sets up to 4 children. Height adjustable from 14"h to 19"h. Chairs not included.
Size: 36"l x 36"w

SUGGESTED SIZE CHART

Age	Chairs	Tables
1-2 Years	5"	12-14"
2 Years	7"	14-16"
2-3 Years	9"	16-18"
3-6 Years	11"	18-20"

Always allow at least 7" between the chair seat and tabletop. Not to exceed 100 total lbs.



Optional seat strap!

Stackable Toddler Chairs

- ANG1360 5"
- ANG1361 7"
- ANG1362 9"
- ANG1363 11"

Stackable chairs are ruggedly constructed of all-birch panels. Convenient handle cutouts make moving the chairs easy. Upgrade chair to include optional seat strap at minimal cost. Please specify by adding 'S' after the item number.

